



Built-In Combination Convection-Microwave/Convection WALL OVEN

SAFETY INFORMATION 3

USING THE OVEN

Oven Controls.....10

Oven Settings 11

Oven Options 12

Baking 13

Warming and Proofing 14

Microwaving 15

Cooking Modes..... 19

Sabbath Mode.....20

Cooking Guide 21

Racks 23

Aluminum Foil and Oven Liners.....24

Cookware.....24

CARE AND CLEANING

Oven.....25

Oven Racks 27

Lower Oven Maintenance.....28

TROUBLESHOOTING TIPS.....29

LIMITED WARRANTY34

ACCESSORIES35

CONSUMER SUPPORT36

OWNER'S MANUAL

PT7800 - 30" Double Wall Oven
PK7800 - 27" Double Wall Oven

Write the model and serial numbers here:

Model # _____

Serial # _____

You can find them on a label on the side trim or on the front of the (lower) oven behind the oven door.

ESPAÑOL

Para consultar una version en español de este manual de instrucciones, visite nuestro sitio de internet GEAppliances.com.

THANK YOU FOR MAKING GE APPLIANCES A PART OF YOUR HOME.

Whether you grew up with GE Appliances, or this is your first, we're happy to have you in the family.

We take pride in the craftsmanship, innovation and design that goes into every GE Appliances product, and we think you will too. Among other things, registration of your appliance ensures that we can deliver important product information and warranty details when you need them.

Register your GE appliance now online. Helpful websites and phone numbers are available in the Consumer Support section of this Owner's Manual. You may also mail in the pre-printed registration card included in the packing material.



GE APPLIANCES

IMPORTANT SAFETY INFORMATION

READ ALL INSTRUCTIONS BEFORE USING THE APPLIANCE

PRECAUTIONS TO AVOID POSSIBLE EXPOSURE TO EXCESSIVE MICROWAVE ENERGY

- (a) **Do Not Attempt** to operate this oven with the door open since open-door operation can result in harmful exposure to microwave energy. It is important not to defeat or tamper with the safety interlocks.
- (b) **Do Not Place** any object between the oven front face and the door or allow soil or cleaner residue to accumulate on sealing surfaces.
- (c) **Do Not Operate** the oven if it is damaged. It is particularly important that the oven door close properly and that there is no damage to the:
 - (1) door (bent),
 - (2) hinges and latches (broken or loosened),
 - (3) door seals and sealing surfaces.
- (d) **The Oven Should Not** be adjusted or repaired by anyone except properly qualified service personnel.

To reduce the risk of burns, electric shock, fire, injury to persons or exposure to excessive microwave energy:

▲WARNING GENERAL SAFETY INSTRUCTIONS

- Read all instructions before using this appliance. When using electrical appliances, basic safety precautions should be followed, including the following:
 - Read and follow the specific precautions in the PRECAUTIONS TO AVOID POSSIBLE EXPOSURE TO EXCESSIVE MICROWAVE ENERGY section.
 - Be sure your appliance is properly installed and grounded by a qualified technician in accordance with the provided installation instructions.
 - Install or locate this appliance only in accordance with the provided installation instructions.
 - Some products such as whole eggs and sealed containers—for example, closed jars—are able to explode and should not be heated in this oven. Such use of the oven could result in injury.
 - Do not mount this appliance over a sink.
 - This oven is not approved or tested for marine use.
 - This oven is UL listed for standard wall installation.
 - Do not operate this appliance if it has been damaged or dropped.
- As with any appliance, close supervision is necessary when used by children.
- Use this appliance only for its intended use as described in this manual.
- Do not use corrosive chemicals or vapors in this appliance.
- This oven is specifically designed to heat, dry or cook food and is not intended for laboratory or industrial use.
- This appliance must only be serviced by qualified service personnel. Contact nearest authorized service facility for examination, repair or adjustment.
- Do not cover or block any openings on the appliance.
- Do not store this appliance outdoors. Do not use this product near water—for example, in a wet basement, near a swimming pool, near a sink or in similar locations.
- See door surface cleaning instructions in the Care and Cleaning of the Oven section of this manual.

READ AND SAVE THESE INSTRUCTIONS

IMPORTANT SAFETY INFORMATION

READ ALL INSTRUCTIONS BEFORE USING THE APPLIANCE

▲WARNING GENERAL SAFETY INSTRUCTIONS (Cont.)

- To reduce the risk of fire in the oven cavity:
 - Do not overcook food. Carefully attend appliance when paper, plastic or other combustible materials are placed inside the oven while microwave cooking.
 - Remove wire twist-ties and metal handles from paper or plastic containers before placing them in the oven.
 - Do not use the oven for storage purposes. Do not leave paper products, cooking utensils or food in the oven when not in use.
 - If materials inside the oven ignite, keep the oven door closed, turn the oven off and shut off power at the fuse or circuit breaker panel. If the door is opened, the fire may spread.
 - Do not use the Sensor Features twice in succession on the same food portion. If food is undercooked after the first countdown, use COOK BY TIME for additional cooking time.
- Do not operate the oven without the turntable in place. The turntable must be unrestricted so it can turn.
- Potentially hot surfaces include the oven door, floor, walls, oven rack and turntable.
- Don't defrost frozen beverages in narrow-necked bottles (especially carbonated beverages). Even if the container is open, pressure can build up. This can cause the container to burst, possibly resulting in injury.
- Foods cooked in liquids (such as pasta) may tend to boil more rapidly than foods containing less moisture. Should this occur, refer to the Care and Cleaning of the oven section for instructions on how to clean the inside of the oven.
- Hot foods and steam can cause burns. Be careful when opening any containers of hot food, including popcorn bags, cooking pouches and boxes. To prevent possible injury, direct steam away from hands and face.
- Do not overcook potatoes. They could dehydrate and catch fire, causing damage to your oven.
- Avoid heating baby food in glass jars, even with the lid off. Make sure all infant food is thoroughly cooked. Stir food to distribute the heat evenly. Be careful to prevent scalding when warming formula. The container may feel cooler than the formula really is. Always test the formula before feeding the baby.
- Do not attempt to deep fry in the oven.

▲WARNING NOTICE—PACEMAKERS

Most pacemakers are shielded from interference from electronic products, including microwaves. However, patients with pacemakers may wish to consult their physicians if they have concerns.

▲WARNING ARCING

Arcing can occur during both speedcooking and microwave cooking. If you see arcing, press the **Clear/Off** pad and correct the problem.

Arcing is the microwave term for sparks in the oven. Arcing is caused by:

- Metal or foil touching the side of the oven.
- Metal, such as twist-ties, poultry pins, or gold-rimmed dishes, in the oven.
- Foil not molded to food (upturned edges act like antennas).
- Recycled paper towels containing small metal pieces being used in the oven.
- Use foil only as recommended in this manual.
- Metal cookware used during either speedcook or microwave cooking (except for the pans provided with the oven).

READ AND SAVE THESE INSTRUCTIONS

IMPORTANT SAFETY INFORMATION

READ ALL INSTRUCTIONS BEFORE USING THE APPLIANCE

▲WARNING FOODS

- When microwaving, place all foods and containers on the clear glass tray.
- Do not pop popcorn in your oven unless in a special microwave popcorn accessory or unless you use popcorn labeled for use in microwave ovens.
- Do not boil eggs in this oven. Pressure will build up inside egg yolk and will cause it to burst, possibly resulting in injury.
- Do not operate the oven without food inside. This may cause damage to the oven. It increases the heat around the magnetron and can shorten the life of the oven.
- Foods with unbroken outer "skin" such as potatoes, hot dogs, sausages, tomatoes, apples, chicken livers and other giblets, and egg yolks should be pierced to allow steam to escape during cooking.

■ SUPERHEATED WATER

Liquids, such as water, coffee or tea, are able to be overheated beyond the boiling point without appearing to be boiling. Visible bubbling or boiling when the container is removed from the microwave oven is not always present. **THIS COULD RESULT IN VERY HOT LIQUIDS SUDDENLY BOILING OVER WHEN THE CONTAINER IS DISTURBED OR A SPOON OR OTHER UTENSIL IS INSERTED INTO THE LIQUID.**

To reduce the risk of injury to persons:

- Do not overheat the liquid.
- Stir the liquid both before and halfway through heating it.
- Do not use straight-sided containers with narrow necks.
- After heating, allow the container to stand in the microwave oven for a short time before removing the container.
- Use extreme care when inserting a spoon or other utensil into the container.

▲WARNING Oven-safe cookware for Baking, Warming & Proofing

The oven and door will get very hot when baking, warming or proofing.

- **Cookware will become hot.** Oven mitts will be needed to handle the cookware.
- Do not cover the turntable, wire oven rack, trays or any part of the oven with metal foil. This will cause arcing in the oven.
- Use the wire oven rack and place cookware on the glass tray when baking on two levels.
- Any oven-safe dish can be used in your oven. Place them directly on the trays.
- Do not use the oven to dry newspapers.
- Use of the clear glass tray when baking, warming or proofing will result in inferior cooking performance.

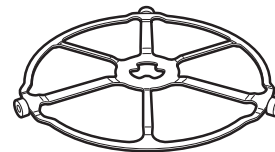

The **turntable** must always be in place when using the oven.

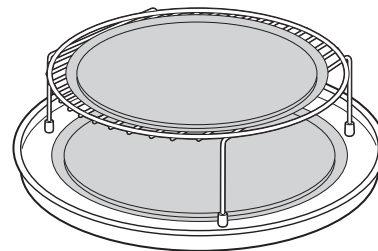

For two-level baking, place food in a baking dish on the glass tray. Place your baking dish with food on top of the wire rack. Stand the rack with food on the glass tray.

READ AND SAVE THESE INSTRUCTIONS

IMPORTANT SAFETY INFORMATION

READ ALL INSTRUCTIONS BEFORE USING THE APPLIANCE

▲WARNING MICROWAVE-SAFE COOKWARE

Make sure to use suitable cookware during microwave cooking. Most glass casseroles, cooking dishes, measuring cups, custard cups, pottery or china dinnerware which does not have metallic trim or glaze with a metallic sheen can be used. Some cookware is labeled “suitable for microwaving.”

- Place food or microwavable container directly on the clear glass tray to cook your food.
- Use of the non-stick metal tray during microwave cooking will result in inferior cooking performance.
- If you are not sure if a dish is microwave-safe, use this test: Place in the oven both the dish you are testing and a glass measuring cup filled with 1 cup of water—set the measuring cup either in or next to the dish. Microwave 30-45 seconds at high. If the dish heats, it should not be used for microwaving.



How to test for a microwave-safe dish.

If the dish remains cool and only the water in the cup heats, then the dish is microwave-safe.

- Cookware may become hot because of heat transferred from the heated food. Oven mitts may be needed to handle the cookware.
- Do not use recycled paper products. Recycled paper towels, napkins and waxed paper can contain metal flecks which may cause arcing or ignite. Paper products containing nylon or nylon filaments should be avoided, as they may also ignite.
- Use foil only as directed in this manual. When using foil in the oven, keep the foil at least 1” away from the sides of the oven.
- Do not use the oven to dry newspapers.
- If you use a meat thermometer while cooking, make sure it is safe for use in microwave ovens.
- Some foam trays (like those that meat is packaged on) have a thin strip of metal embedded in the bottom. When microwaved, the metal can burn the floor of the oven or ignite a paper towel.

- Paper towels, waxed paper and plastic wrap can be used to cover dishes in order to retain moisture and prevent spattering. Be sure to vent plastic wrap so steam can escape.
- Not all plastic wrap is suitable for use in microwave ovens. Check the package for proper use.
- “Boilable” cooking pouches and tightly closed plastic bags should be slit, pierced or vented as directed by package. If they are not, plastic could burst during or immediately after cooking, possibly resulting in injury. Also, plastic storage containers should be at least partially uncovered because they form a tight seal. When cooking with containers tightly covered with plastic wrap, remove covering carefully and direct steam away from hands and face.
- Plastic cookware—Plastic cookware designed for microwave cooking is very useful, but should be used carefully. Even microwave-safe plastic may not be as tolerant of overcooking conditions as are glass or ceramic materials and may soften or char if subjected to short periods of overcooking. In longer exposures to overcooking, the food and cookware could ignite.

Follow these guidelines:

1. Use microwave-safe plastics only and use them in strict compliance with the cookware manufacturer’s recommendations.
2. Do not microwave empty containers.
3. Do not permit children to use plastic cookware without complete supervision.

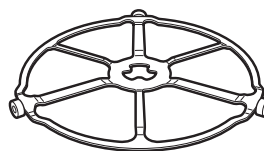

The turntable must always be in place when using the oven.

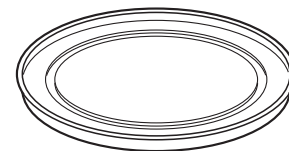

The clear glass tray should always be in place when microwaving.

READ AND SAVE THESE INSTRUCTIONS

IMPORTANT SAFETY INFORMATION

READ ALL INSTRUCTIONS BEFORE USING THE APPLIANCE

▲WARNING Read all safety instructions before using the product. Failure to follow these instructions may result in fire, electrical shock, serious injury or death.

▲WARNING GENERAL SAFETY INSTRUCTIONS

- Use this appliance only for its intended purpose as described in this Owner's Manual.
- Be sure your appliance is properly installed and grounded by a qualified installer in accordance with the provided installation instructions.
- Do not attempt to repair or replace any part of your oven unless it is specifically recommended in this manual. All other servicing should be transferred to a qualified technician.
- Before performing any service, disconnect the power supply at the household distribution panel by removing the fuse or switching off the circuit breaker.
- Do not leave children alone—children should not be left alone or unattended in an area where an appliance is in use. They should never be allowed to climb, sit or stand on any part of the appliance.
- **▲CAUTION** Do not store items of interest to children in cabinets above an oven - children climbing on the oven to reach items could be seriously injured.
- Use only dry pot holders—moist or damp pot holders on hot surfaces may result in burns from steam. Do not let pot holders touch hot heating elements. Do not use a towel or other bulky cloth in place of pot holders.
- Never use your appliance for warming or heating the room.
- Do not touch the heating elements or the interior surface of the oven. These surfaces may be hot enough to burn even though they are dark in color. During and after use, do not touch, or let clothing or other flammable materials contact any interior area of the oven; allow sufficient time for cooling first. Other surfaces of the appliance may become hot enough to cause burns. Potentially hot surfaces include the oven vent opening, surfaces near the opening and crevices around the oven door.
- Do not heat unopened food containers. Pressure could build up and the container could burst, causing an injury.
- Do not use any type of foil or liner to cover the oven bottom or anywhere in the oven, except as described in this manual. Oven liners can trap heat or melt, resulting in damage to the product and risk of shock, smoke or fire.
- Avoid scratching or impacting glass doors or control panels. Doing so may lead to glass breakage. Do not cook on or in a product with broken glass. Shock, fire or cuts may occur.
- Cook food thoroughly to help protect against foodborne illness. Minimum safe food temperature recommendations can be found at www.IsItDoneYet.gov and www.fsis.usda.gov. Use a food thermometer to take food temperatures and check several locations.

▲WARNING KEEP FLAMMABLE MATERIALS AWAY FROM THE RANGE

Failure to do so may result in fire or personal injury.

- Do not store or use flammable materials in an oven or near the cooktop, including paper, plastic, pot holders, linens, wall coverings, curtains, drapes and gasoline or other flammable vapors and liquids.
- Never wear loose-fitting or hanging garments while using the appliance. These garments may ignite if they contact hot surfaces causing severe burns.
- Do not let cooking grease or other flammable materials accumulate in or near the range. Grease in the oven or on the cooktop may ignite.

READ AND SAVE THESE INSTRUCTIONS

IMPORTANT SAFETY INFORMATION

READ ALL INSTRUCTIONS BEFORE USING THE APPLIANCE

▲WARNING IN THE EVENT OF A FIRE, TAKE THE FOLLOWING STEPS TO PREVENT INJURY AND FIRE SPREADING

- Do not use water on grease fires. Never pick up a flaming pan.
- If there is a fire in the oven during baking, smother the fire by closing the oven door and turning the oven off or by using a multi-purpose dry chemical or foam-type fire extinguisher.
- If there is a fire in the oven during self-clean, turn the oven off and wait for the fire to go out. Do not force the door open. Introduction of fresh air at self-clean temperatures may lead to a burst of flame from the oven. Failure to follow this instruction may result in severe burns.

▲WARNING OVEN SAFETY INSTRUCTIONS

- Stand away from the oven when opening the oven door. Hot air or steam which escapes can cause burns to hands, face and/or eyes.
- Keep the oven vent unobstructed.
- Keep the oven free from grease buildup. Grease in the oven may ignite.
- Place oven racks in desired location while oven is cool. If rack must be moved while oven is hot, do not let pot holder contact hot heating element in oven.
- When using cooking or roasting bags in the oven, follow the manufacturer's directions.
- Pulling out the standard racks to their stop-locks or the extension rack to its fully open position is a convenience in lifting heavy foods. It is also a precaution against burns from touching hot surfaces of the door or oven walls.
- Do not leave items such as paper, cooking utensils or food in the oven when not in use. Items stored in an oven can ignite.
- Never place cooking utensils, pizza or baking stones, or any type of foil or liner on the oven floor. These items can trap heat or melt, resulting in damage to the product and risk of shock, smoke or fire.

▲WARNING SELF-CLEANING OVEN SAFETY INSTRUCTIONS

The self-cleaning feature operates the oven at temperatures high enough to burn away food soils in the oven. Follow these instructions for safe operation.

- Do not touch oven surfaces during self-clean operation. Keep children away from the oven during self-cleaning. Failure to follow these instructions may cause burns.
- Before self-cleaning the oven, remove shiny silver colored oven racks (on some models), the probe, any aluminum foil, and any broiler pan, grid, and other cookware. Only porcelain coated oven racks may be left in the oven.
- Before operating the self-clean cycle, wipe grease and food soils from the oven. Excessive amount of grease may ignite, leading to smoke damage to your home.
- If the self-cleaning mode malfunctions, turn the oven off and disconnect the power supply. Have it serviced by a qualified technician.
- Do not clean the door gasket. The door gasket is essential for a good seal. Care should be taken not to rub, damage or move the gasket.
- Do not use oven cleaners. No commercial oven cleaner or oven liner protective coating of any kind should be used in or around any part of the oven.

READ AND SAVE THESE INSTRUCTIONS

IMPORTANT SAFETY INFORMATION

READ ALL INSTRUCTIONS BEFORE USING THE APPLIANCE

FCC RADIO FREQUENCY INTERFERENCE

This equipment generates and uses ISM frequency energy and if not installed and used properly, that is in strict accordance with the manufacturer's instructions, may cause interference to radio and television reception. It has been type tested and found to comply with limits for an ISM Equipment pursuant to part 18 of FCC Rules, which are designed to provide reasonable protection against such interference in a residential installation. However, there is no guarantee that interference will not occur in a particular installation. If this equipment does cause interference to radio or television reception, which can be determined by turning the equipment off and on, the user is encouraged to try to correct the interference by one or more of the following:

- Reorient the receiving antenna of radio or television.
- Relocate the Microwave oven with respect to the receiver.
- Move the microwave oven away from the receiver.
- Plug the microwave oven into a different outlet so that microwave oven and receiver are on different branch circuits.

The manufacturer is not responsible for any radio or TV interference caused by **unauthorized modification** to this microwave oven. It is the responsibility of the user to correct such interference.

How to Remove Protective Shipping Film and Packaging Tape

Carefully grasp a corner of the protective shipping film with your fingers and slowly peel it from the appliance surface. Do not use any sharp items to remove the film. Remove all of the film before using the appliance for the first time.

To assure no damage is done to the finish of the product, the safest way to remove the adhesive from packaging tape on new appliances is an application of a household liquid dishwashing detergent. Apply with a soft cloth and allow to soak.

NOTE: The adhesive must be removed from all parts. It cannot be removed if it is baked on.

READ AND SAVE THESE INSTRUCTIONS

Oven Controls

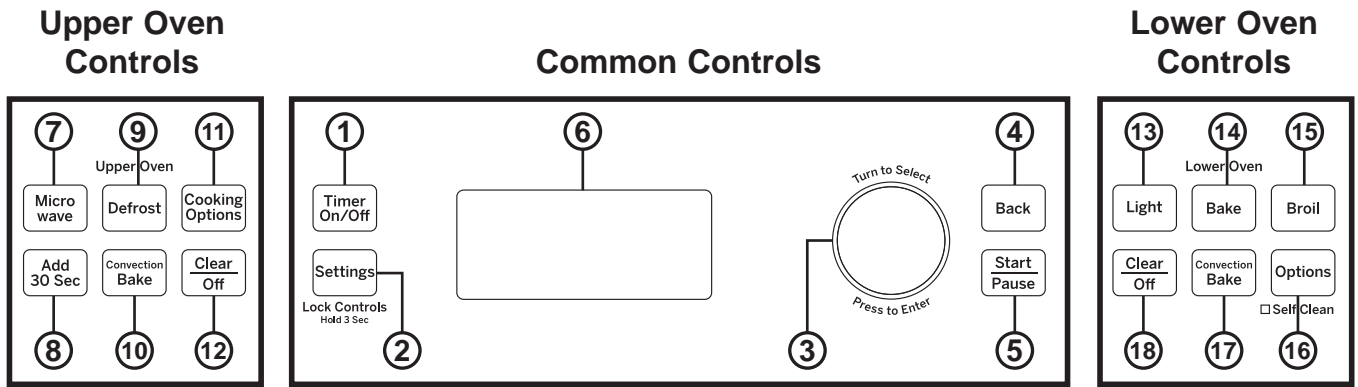

Common Controls

- 1. Timer On/Off:** Works as a countdown timer. Press the **Timer On/Off** pad, select the timer type (hours and minutes or minutes and seconds), use the selector dial to set the time, and press the selector dial to start the timer countdown. The oven will continue to operate when the timer countdown is complete. To turn the timer off, press the **Timer On/Off** pad.
- 2. Settings / Lock Controls:** Find oven options for: Help, Clock Settings, Display Mode, Auto Conversion, Auto Shut Off, Beeper Volume, Reminder, Temperature Units, Thermostat Adjust and Oven Information under this selection. See the Oven Settings section for more details. Press and hold **Settings** pad for 3 seconds to lock or unlock the controls. This locks out the control so that pressing any of the control pads does not activate the feature. Clear/Off is always active, even when the control is locked.
- 3. Selector Dial:** The selector dial is used for both the upper and lower ovens. Rotate dial to select oven settings, upper/lower oven options and cooking options then press to confirm the selection. Rotate dial to increase or decrease temperatures or time and then press to confirm the set temperature or time.
- 4. Back:** Press this pad to go back a menu level in the display.
- 5. Start/Pause:** Press the **Start/Pause** pad to start any cooking, clean or timed function. Press the **Start/Pause** pad to pause any upper oven features.
- 6. Display:** Information about both the upper and lower ovens is shown in this display window.

Upper Oven Controls

- 7. Microwave:** Press the **Microwave** pad for microwaving options. Use the selector dial to find the microwaving option desired and press the selector dial to select it. Options available include Cook by Time, Cook, Defrost, Beverage, Popcorn, Melt, Reheat, Simmer and Soften. Use the clear glass tray and microwave-safe cookware when using the microwave features. See Upper Oven Microwaving section for more detail.
- 8. Add 30 Sec:** Press the **Add 30 Sec** pad for 30 seconds of microwave cooking time. Each time this pad is pressed an additional 30 seconds is added to the remaining cooking time. The oven starts immediately.

- 9. Defrost:** Press the **Defrost** pad to defrost, rotate selector dial to select the type of defrost and press to select. Type of defrost available include; Defrost by Food Type, Defrost by Time, Defrost by Weight, 1.0 lb. Quick Defrost, Melt, and Soften. See the Microwaving section for more information.
- 10. Convection Bake:** Press the **Convection Bake** pad to convection bake in the upper oven. Place food or oven safe dish on the glass tray when using the convection bake feature. When convection baking on two levels, place food or oven safe dish on the wire oven rack and place them on the glass tray. See Upper Oven Baking for more detail.
- 11. Cooking Options:** Find the Repeat Last, Proof and Warm features under this selection. See the Oven Options section for more details.
- 12. Clear/Off:** The Clear/Off pad cancels ALL upper oven programs except the clock and timer.

Lower Oven Controls

- 13. Light:** Press the **Light** pad to turn the oven light on or off in the lower oven. Note that light in the lower oven will not turn on if the oven is in a clean mode.
- 14. Bake:** Press the **Bake** pad to bake, rotate selector dial to select baking temperature and press to select.
- 15. Broil:** Press the **Broil** pad to broil, rotate selector dial to select Hi/Lo and press to select.
- 16. Options:** Find the Delay Start, Probe, Proof, Sabbath, Self Clean, Steam Clean and Warm features under this selection. See the Oven Options section for more details.
- 17. Convection Bake:** Press the **Convection Bake** pad to convection bake. Convection cook modes use increased air circulation to improve performance. The type of benefit depends on the mode. Your lower oven has the following convection cooking modes: Convection Bake (1 Rack/Multi) and Convection Roast. See the Lower Oven Cooking Modes section for more information.
- 18. Clear/Off:** The Clear/Off pad cancels ALL lower oven programs except the clock and timer.

Oven Settings

Help

Use this feature to find out more about your oven and its features by pressing the **Settings** pad and selecting help. Turn the selector dial and press to select the feature you want to find out more about.

NOTE: Not all features of help may be on your oven model. Below are features found in the Help function:

Features found in the Help function.

Adding Time	Defrost by Weight	Start/Pause
Auto Conversion	Delay Start (Lower)	Steam Clean
Auto Shut-Off	Display Mode	Temperature Units
Back	Edit	Thermostat Adjust
Bake	Help	Timer On/Off
Beeper Volume	Melt	Toast
Beverage	Micro 30 Secs	Warm
Broil	Microwave	
Clear/Off	My Recipes	
Clock	Probe	
Control Lockout	Proof	
Cook	Reheat	
Cook by Food	Reminder	
Cook by Time	Repeat Last	
Cook by Time 1 & 2	Resume	
Cooking Options (Lower)	Sabbath	
Cooking Options (Upper)	Self Clean	
Defrost	Sensor Cooking	
Defrost by Food	Simmer	
Defrost by Time	Soften	
	Speed Cook	

Clock Settings

Use this feature to set the time of day and to specify how the time of day will be displayed. You can select a standard 12-hour clock (12 hr) or 24-hour military time display (24 hr). Prior to the first use of your oven, the clock must be set.

Display Mode

Use this feature to set Power Saver or Display Always On display mode.

Auto Conversion

Use this feature to turn Auto Conversion on/off. When Auto Conversion is on it will automatically convert the regular baking temperatures entered to convection bake cooking temperatures when using convection bake. This adjusts the temperature in both ovens.

Auto Shut-Off

Use this feature to activate/deactivate Auto Shut-Off. Activating the Auto Shut-Off feature will turn off the lower oven after 12 hours of continuous operations. The factory setting for Auto Shut-Off feature is activated. When in Sabbath mode Auto Shut-Off will be deactivated.

Beeper Volume

Use this feature to set Beeper Volume to Mute or Normal.

NOTE: Some tones are not mutable.

Reminder

Use this feature to Set, Review, or Clear Reminder.

Temperature Units

Use this feature to set the display temperature unit to °F (Fahrenheit) or °C (Celsius).

Thermostat Adjust

This feature allows the oven baking and convection baking temperature to be adjusted up to 35°F hotter or down to 35°F cooler on the lower oven. The upper oven cannot be adjusted. Use this feature if you believe your oven temperature is too hot or too cold and wish to change it. This adjustment affects Bake, and Convection Bake modes. No other cooking modes are affected.

Oven Information

This feature shows the Oven Model and Serial number.

Oven Options

Upper Oven Options

Repeat Last

This feature can only be used for upper oven cooking modes. Use this time saving feature for cooking repetitive items like cookies or appetizers. When selecting this feature, the last preset food will be displayed. Select **Start/Pause** pad or the selector dial to start cooking.

NOTE: The last program used is stored for two hours. Not all features can be repeated.

Proof

Use this feature to proof bread. See Upper Oven Warming and Proofing section for more detail.

Warm

Use this feature to warm. Select Moist or Crisp. See Upper Oven Warming and Proofing section for more detail.

Lower Oven Options

Delay Start

Use this feature to delay starting a Bake, Conv Bake, Probe, or Self Clean feature. To use this feature select Delay Start and set the time to start, then select cook mode. You can also use the Delay Start feature while programming a Bake, Conv Bake, or Probe cooking feature.

Probe

Use this feature to cook by the internal temperature of the food. For many foods, especially roast and poultry, internal food temperature is the best test for doneness. This feature is available for the lower oven only. To use this feature, insert probe into food. Select Probe then enter the desired internal food temperature and program the Bake or Conv Bake cooking mode as normal. This feature can also be accessed by connecting the temperature probe into the oven at any time.

Proof

Use this feature to proof dough. See Lower Oven Cooking Modes for more detail.

Sabbath

Use this feature to enter Sabbath mode. Sabbath mode sets the oven for observance of the Jewish Sabbath and Holidays. This feature conforms to the Star-K Jewish Sabbath requirements. Sabbath mode disables the oven lights (the oven light will not turn on when the door is opened), all sounds (the control will not beep when a button is pressed, but will still beep if certain oven faults occur), and all upper oven functions and lower oven

functions, except lower oven Bake. During Sabbath mode only lower oven Bake is available. While in Sabbath mode, after setting/changing a bake temperature, a random delay of approximately 30 seconds to 1 minute will occur before the oven will begin baking. To stop cooking, press the **Back** pad and then the **Start/Pause** pad. Your oven will shut off after a random delay of approximately 30 seconds to 1 minute. To immediately exit lower oven Bake, press the **Clear/Off** pad at any time – cooking elements will immediately turn off and Sabbath Bake will change to Sabbath on the display, indicating that the oven has turned off. To exit Sabbath mode press and hold the **Back** pad for 3 seconds. Do not press any other buttons until Sabbath mode has exited, or Sabbath mode will be re-initialized and will not exit. See Lower Oven Sabbath Mode for more detail.

NOTE: If power outage occurs during Sabbath mode the unit will remain in Sabbath mode but will no longer be cooking when power is restored.

Self Clean

Use this feature to enter Self Clean mode. See Cleaning The Oven section for more detail.

Steam Clean

Use this feature to enter Steam-Clean mode. See Cleaning The Oven section for more detail.

Warm

Use this feature to warm. See Lower Oven Cooking Modes for more detail.

Baking

Baking

Baking allows you to cook foods the same way as a conventional oven, using a heating element to raise the temperature of the air inside the oven. Any oven temperature from 250°F to 450°F may be set.

A fan gently circulates heated air throughout the oven, over and around the food. Because the heated air is kept constantly moving, not permitting a layer of cooler air to develop around the food, some foods cook slightly faster than in regular oven cooking.

Before you begin, make sure the turntable is in place.

CAUTION When baking, remember that the oven, door and dishes will be very hot!

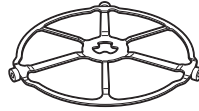

The **turntable** must always be in place when using the oven.

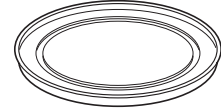

Put food or oven-safe cookware directly on the **glass tray to bake**.

How To Bake

1. Press the **Convection Bake** pad.
2. Turn the selector dial to set the oven temperature and press to enter.
3. Select **Start** or **Cook Time**.

Preheat after selecting start:

1. The oven starts preheating immediately. Do not place the food in the oven.
2. When the oven is finished preheating, it will signal. If you do not open the door within 1 hour, the oven will turn off automatically. Open the oven door and, using caution, place the food in the oven.
3. Close the oven door. Press the selector dial twice to set the cook time and press **Start/Pause** to start cooking. When cooking is complete, the oven will signal and turn off.

You may change the oven temperature during preheating by pressing the selector dial and turning the selector dial to select the new temperature.

If the oven door is opened during cooking, Pause will appear in the display. Close the door and press **Start/Pause**. Limit door openings for optimal results at high temperatures.

Cook times are shown in minutes and can be a maximum of 179 minutes. Time can be changed during cooking by turning the selector dial.

Preheat after selecting cook time:

1. After selecting a cook time, oven will prompt you to start cook time or start preheat.
2. Press start cook time to skip preheat or press start preheat to preheat.
3. When the oven is finished preheating, it will signal. If you do not open the door within 1 hour, the oven will turn off automatically. Open the oven door and, using caution, place the food in the oven.
4. Close the oven door. Press selector dial to edit temperature or cook time, if needed and/or press **Start/Pause** to start cooking. When cooking is complete the oven will signal and turn off.

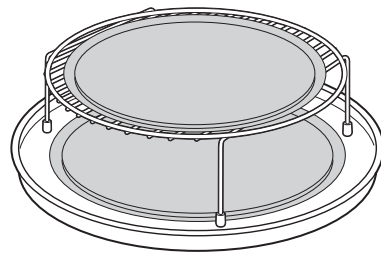

For two-level baking, place food in a baking dish on the glass tray. Place your baking dish with food on top of the wire rack. Stand the rack with food on the glass tray.

Warming and Proofing

Warming

The Warm feature will keep hot, cooked foods at serving temperature. Always start with hot food. Use cookware and utensils that can withstand temperatures up to 230°F.

1. Press the **Cooking Options** pad.
2. Turn the selector dial to Warm. Press the selector dial to enter.
3. Turn the selector dial to select Moist/Crisp. Press the selector dial to enter.

If the oven door is opened during warming, Pause will appear in the display. Close the door and press **Start/Pause**.

To Crisp Stale Items:

- Place food or dishes on the glass tray.
- Check crispness periodically. Add time as needed.

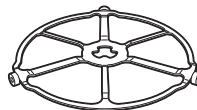

The **turntable** must always be in place when using the oven.



Put food on the glass tray to warm.

Temperature and Moisture Selection Chart

Food Type	Moisture Setting
Bread, hard rolls	CRISP
Bread, soft rolls	MOIST
Casseroles	MOIST
Fried foods	CRISP
Meats* and fish	CRISP
Pancakes, waffles	CRISP
Pizza	CRISP
Potatoes, baked	CRISP
Potatoes, mashed	MOIST
Poultry	MOIST
Tortilla Chips	CRISP
Vegetables	MOIST

* USDA/FSIS recommends an internal temperature of 145°F as the acceptable holding temperature for beef. Use a portable meat thermometer to check internal temperatures.

Tips for Crisp Foods:

- Leave food uncovered.
- Do not use plastic containers or plastic wrap.

Tips for Moist Foods:

- Cover food with lid or aluminum foil.
- Do not use plastic containers or plastic wrap.

Proofing

The proofing feature automatically provides the optimum temperature for the proofing process, and therefore does not have a temperature adjustment.

1. Press the **Cooking Options** pad.
 2. Turn the selector dial to select Proof. Press the selector dial to enter. The upper oven starts proofing immediately and shows the amount of proofing time completed.
- To optimize performance avoid unnecessary door opening.
 - Check bread products early to avoid over-proofing.

NOTES:

- Do not use the proofing mode for warming food or keeping food hot. The proofing oven temperature is not hot enough to hold foods at safe temperatures. Use the Warm feature to keep food warm.
- Proofing will not operate if the oven is too hot. Allow the oven to cool before proofing.

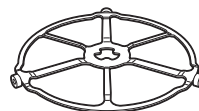

The **turntable** must always be in place when using the oven.



Put bread dough in a bowl/ bread pan and place on the glass tray to proof.

Microwaving

Using The Microwave Features

Make sure the turntable and clear glass tray are in place.

Place food or microwavable container directly on the clear glass tray to cook your food.

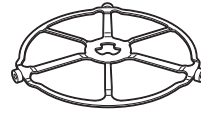

The **turntable** must always be in place when using the oven.

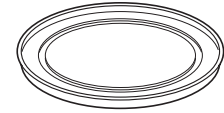

The **clear glass tray** should always be in place when **microwaving**.

MICROWAVE PRESET SELECTIONS:

- | | | | | |
|---|---|--|--|--|
| <ul style="list-style-type: none"> ■ Beverage <ul style="list-style-type: none"> – Water (8-12 oz.) – Coffee (8-12 oz.) – Tea (8-12 oz.) – Milk (8-12 oz.) – Hot Cocoa (8-12 oz.) ■ Popcorn <ul style="list-style-type: none"> – Popcorn Sensor | <ul style="list-style-type: none"> ■ Melt <ul style="list-style-type: none"> – Butter – Caramel – Cheese – Chocolate Chips – Marshmallow ■ Simmer | <ul style="list-style-type: none"> ■ Cook <ul style="list-style-type: none"> – By Food Type – By Time – By Time 1 & 2 ■ Soften <ul style="list-style-type: none"> – Butter – Cream Cheese – Frosting (16 oz.) – Ice Cream | <ul style="list-style-type: none"> ■ Defrost <ul style="list-style-type: none"> – 1.0 lb Quick – By Time – By Weight – By Food Type – Melt – Soften | <ul style="list-style-type: none"> ■ Reheat <ul style="list-style-type: none"> – Beverage – Casserole – Chicken – Pasta – Pizza – Plate of Food – Rice – Soup – Steaks/Chops – Vegetables |
|---|---|--|--|--|

How To Use Pre-Set Microwave Selections

1. Press the **Microwave** pad.
If no selection is made within 15 seconds, the display will revert back to the time of day.
2. Turn the selector dial to find the food or beverage you want to cook, defrost, soften, melt, simmer or reheat. Press the selector dial to enter.
3. Turn the selector dial to select the type, amount, weight and/or size. (As required, the oven will prompt you.) Press the selector dial after each selection.
4. Press the selector dial or the **Start/Pause** pad to start cooking.

To review or edit settings during cooking, press the selector dial.

If the door is opened during cooking, the oven will stop and **PAUSE** will appear in the display. Close the door and press **Start/Pause** pad to resume cooking.

If you enter an undesired selection at any time, simply press the **Back** pad and reenter the desired selections.

- When the oven is on, light may be visible around the door or outer case.
- The oven cavity light will come on during a microwave cooking cycle.
- Steam or vapor may escape from around the door.

Cook By Time And Cook By Time 1 & 2

Use Cook By Time and Cook By Time 1 & 2 to microwave food that is not in the recipe section and at the time(s) you set.

- The power level is automatically set at high, but you can change it for more flexibility.
1. Press the **Microwave** pad.
 2. Turn the selector dial to select Cook By Time or Cook By Time 1 & 2 and press the selector dial to enter.
 3. Turn the selector dial to set the cook time and press the selector dial to enter.

4. Select power level setting.

If you selected Cook By Time 1 & 2, turn the selector dial to set the second cook time, second power level setting and press the selector dial to enter.

5. Press the selector dial or the **Start/Pause** pad to start cooking.

You may open the door during Cook By Time and Cook By Time 1 & 2 to check the food. Close the door and press **Start/Pause** to resume cooking.

Microwaving (Cont.)

Microwave Power Level(s)

- You can change the power level during most cooking program.
1. Press the selector dial to edit
 2. Rotate selector dial to change time and/or press selector dial to enter.
 3. Turn the selector dial clockwise to increase and counterclockwise to decrease the power level. Press the selector dial to enter.

Here are some examples of uses for various power levels:

High 10: Fish, bacon, vegetables, boiling liquids.

Med-High 7: Gentle cooking of meat and poultry; baking casseroles and reheating.

Medium 5: Slow cooking and tenderizing for stews and less tender cuts of meat.

Low 2 or 3: Defrosting, simmering, delicate sauces.

Warm 1: Keeping food warm, softening butter.

Defrost By Food Type

Auto Defrost automatically sets the defrosting times and power levels to give even defrosting results for meats, poultry and fish weighing up to 6 pounds.

1. Remove food from the package and place it on a microwave-safe dish.
2. Press the **Microwave** pad and select defrost.
3. Turn the selector dial to Defrost By Food Type. Press the selector dial to enter.
4. Turn the selector dial to select food type. Press the selector dial to enter.
5. Turn the selector dial to the food weight, using the Conversion Guide at the right. For example, dial 1.2 for 1.2 pounds (1 pound, 3 oz.) Press the selector dial to enter.
6. Press the selector dial or **Start/Pause** pad to start defrosting.
7. Turn the food over when the oven signals Turn Food Over.

- Remove defrosted meat or shield warm areas with small pieces of foil for even defrosting.
- After defrosting, most meats need to stand 5 minutes to complete defrosting. Large roasts should stand for about 30 minutes.

Conversion Guide

If the weight of food is stated in pounds and ounces, the ounces must be converted to tenths (.1) of a pound.

Weight of Food in Ounces	Enter Food Weight (tenths of a pound)
1–2	.1
3	.2
4–5	.3
6–7	.4
8	.5
9–10	.6
11	.7
12–13	.8
14–15	.9

Defrost By Time

Use Defrost By Time to defrost for a selected length of time.

1. Press the **Microwave** pad and select defrost.
2. Turn the selector dial to Defrost By Time. Press the selector dial to enter.
3. Turn the selector dial to select the time you want. Press the selector dial to enter.
4. Press the selector dial or **Start/Pause** pad to start defrosting.
5. Turn the food over when the oven signals Turn Food Over.

Power level is automatically set at 3, but can be changed. To change the power levels, see the Microwave Power Level(s) section. You can defrost small items quickly by raising the power level after entering the time. Power level 7 cuts the total defrosting time in about half; power level 10 cuts the total time to about 1/3. When defrosting at high power levels, food will need more frequent attention than usual.

Microwaving (Cont.)

Defrost By Weight

Use Defrost By Weight to defrost for a selected length of time.

1. Press the **Microwave** pad and select defrost.
2. Turn the selector dial to Defrost By Weight. Press the selector dial to enter.
3. Turn the selector dial to select the weight you want. Press the selector dial to enter.

4. Press the selector dial or Start/Pause pad to start defrosting.
5. Turn the food over when the oven signals Turn Food Over.

Power level cannot be changed during this setting.

1.0 lb. Quick Defrost

Use 1.0 lb. Quick Defrost for quick defrost of 1.0 lb. of frozen food.

1. Press the **Microwave** pad and select 1.0 Lb. quick defrost.
2. Press selector dial or **Start/Pause** pad to start defrosting. Press the selector dial to enter.

3. Turn the food over when the oven signals Turn Food Over.

Power level cannot be changed during this setting.

Defrosting Tips

- Foods frozen in paper or plastic can be time defrosted in the package, but foods should be taken out of the package when using Defrost By Food Type. Closed packages should be slit, pierced or vented **after** food has partially defrosted. Plastic storage containers should be partially uncovered.
- Family-size, prepackaged frozen dinners can be defrosted and microwaved. If the food is in a foil container, transfer it to a microwave-safe dish.
- Foods that spoil easily should not be allowed to sit out for more than one hour after defrosting. Room temperature promotes the growth of harmful bacteria.
- For more even defrosting of larger foods, such as roasts, use Defrost By Time. Be sure large meats are completely defrosted before cooking.
- When defrosted, food should be cool but softened in all areas. If still slightly icy, return to the microwave very briefly, or let it stand a few minutes.

Microwaving (Cont.)

Microwave Sensor Cooking

The sensor feature detects the increasing humidity released during cooking. The oven automatically adjusts the cooking time to various types and amounts of food.

Do not use the Sensor Features twice in succession on the same food portion—it may result in severely overcooked or burnt food. If food is undercooked after the first countdown, use Cook By Time for additional cooking time.

The proper containers and covers are essential for best sensor cooking.

- Always use microwave-safe containers and cover them with lids or vented plastic wrap. Never use tight sealing plastic containers—they can prevent steam from escaping and cause food to overcook.
- Be sure the outside of the cooking containers and the inside of the oven are dry before placing food in the oven. Beads of moisture turning into steam can mislead the sensor.
- Beverages are best heated uncovered.



Covered



Vented

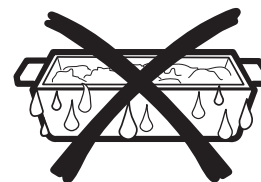

Dry off dishes so they don't mislead the sensor.

MICROWAVE SENSOR PROGRAMS:

- | | | |
|---------------|---|------------------------|
| ■ Ground Meat | ■ Vegetables
(Canned, Fresh, Frozen) | ■ Plate of Food Reheat |
| ■ Popcorn | ■ Chicken Reheat | ■ Soup Reheat |
| ■ Soup | ■ Pasta Reheat | ■ Vegetable Reheat |
| ■ Rice | | |

To Use All Sensor Programs

Upper Oven microwave mode features sensor cooking. It automatically senses when food is done and shuts itself off—eliminating the need to program cook times and power levels.

1. Press the **Microwave** pad and turn the selector dial to Cook By Food Type or Reheat. Press the selector dial to enter.
2. Turn the selector dial to select the food you want. Press the selector dial to enter.
3. Press the selector dial or press the **Start/Pause** pad to start cooking.

Do not open the oven door until time is counting down in the display or the microwave stop cooking. If the door is opened, close it and press **Start/Pause** immediately. If the food is not done enough, use Cook By Time in the microwave selector to cook for more time.

NOTE: Do not use the Sensor Features twice in succession on the same food portion—it may result in severely overcooked or burnt food.

- If you have been speedcooking and the oven is already hot, it may indicate that it is too hot for sensor cooking. Of course, you can always continue with Cook By Time.

NOTE: If the oven is too hot then it will automatically change to time cooking.

- To shorten or lengthen the cook time, wait until the time countdown shows in the display. Then turn the selector dial to add or subtract time.
- If you open the door while Sensor Cooking, Sensor Error will appear. Close the door, press **Start/Pause** to begin again.

Notes about the Reheat program:

Reheated foods may have wide variations in temperature. Some areas may be extremely hot.

It is best to use Cook By Time and not Reheat for these foods:

- Bread products
- Food that must be reheated uncovered.
- Foods that need to be stirred or turned.
- Foods calling for a dry look or crisp surface after reheating.

Cooking Modes

Your new oven has a variety of cooking modes to help you get the best results. These modes are described below. Refer to the Cooking Guide section for recommendations for specific foods. Remember, your new oven may perform differently than the oven it is replacing.

Baking and Roasting Modes

Select a mode for baking and roasting based on the type and quantity of food you are preparing. When preparing baked goods such as cakes, cookies, and pastries always preheat the oven first. Follow recipe recommendations for food placement. If no guidelines are provided, center food in the oven.

Traditional Bake

The traditional bake mode is intended for single rack cooking. This mode uses heat primarily from the lower element but also from the upper element to cook food. To use this mode press the **Bake** pad, turn the selector dial to set the oven temperature and press to enter, then press **Start**. Preheating is generally recommended when using this mode.

Convection Bake 1 Rack

The Convection Bake 1 Rack mode is intended for single rack cooking. This mode uses heat from the lower element and also the upper and rear elements, along with air movement from the convection fan to enhance evenness. Your oven is equipped with Auto Recipe Conversion, so it is not necessary to convert the temperature when using this mode. To use this mode press the **Convection Bake** pad, turn the selector dial to select 1 Rack and set the oven temperature, and press to enter, then press **Start**. Preheating is generally recommended when using this mode.

Convection Bake Multi Rack

The Convection Bake Multi Rack mode is intended for baking on multiple racks at the same time. This mode uses heat primarily from the rear element but also heat from the upper and lower elements, along with air movement from the convection fan to enhance cooking evenness. Your oven is equipped with Auto Recipe Conversion, so it is not necessary to convert the temperature when using this mode. Baking time might be slightly longer for multiple racks than what would be expected for a single rack. To use this mode press the **Convection Bake** pad, turn the selector dial to select Multi Rack and set the oven temperature and press to enter, then press **Start**. Always preheat when using this mode.

Convection Roast

The Convection Roast mode is intended for roasting whole cuts of meat on a single rack. This mode uses heat from the lower, upper, and rear elements along with air movement from the convection fan to improve browning and reduce cooking time. It is not necessary to convert temperature. Check food earlier than the recipe suggested time when using this mode, or use a meat probe. To use this mode press the **Convection Bake** pad, turn the selector dial to select Roast and set the oven temperature and press to enter, then press **Start**. It is not necessary to preheat when using this mode.

Broiling Modes

Always broil with the door closed. The broil element in this oven is very powerful. Monitor food closely while broiling. Use caution when broiling on upper rack positions as placing food closer to the broil element increases smoking, spattering, and the possibility of fats igniting. **Broiling on rack position 6 is not recommended.**

Try broiling foods that you would normally grill. Adjust rack positions to adjust the intensity of the heat to the food. Place foods closer to the broil element when a seared surface and rare interior is desired. Thicker foods and foods that need to be cooked through should be broiled on a rack position farther from the broiler or by using Broil Lo. For best performance center food below the broil heating element.

Broil Hi

The Traditional Broil Hi mode uses intense heat from the upper element to sear foods. Use Broil Hi for thinner cuts of meat and/ or foods you prefer less done on the interior. To use this mode press the **Broil** pad, turn the selector dial to Hi and press to enter, and then press **Start**. It is not necessary to preheat when using this mode.

Broil Lo

The Traditional Broil Lo mode uses less intense heat from the upper element to cook food thoroughly while also producing surface browning. Use Broil Lo for thicker cuts of meat and/or foods that you would like cooked all the way through. To use this mode press the **Broil** pad, turn the selector dial to Lo and press to enter, and then press **Start**. It is not necessary to preheat when using this mode.

Proof

Proof mode is designed for rising (fermenting and proofing) bread dough. Press the **Options** pad, turn the selector dial to select Proof and press to select, then press **Start**. Cover dough well to prevent drying out. Bread will rise more rapidly than at room temperature. Note that for double wall ovens, proof cannot be run when running a clean mode in the lower oven.

Warm

Warm mode is designed to keep hot foods hot for up to 3 hours. To use this mode, press the **Options** pad, turn the selector dial to select Warm and press to select, then press **Start**. Cover foods that need to remain moist and do not cover foods that should be crisp. Preheating is not required. Do not use warm to heat cold food other than crisping crackers, chips or dry cereal. It is also recommended that food not be kept warm for more than 2 hours.

Sabbath Mode

Your new oven conforms to the Star-K Jewish Sabbath requirements with the Sabbath mode cooking feature. Below describes the detail of Sabbath mode feature.

To Enter Sabbath Mode

Press the lower oven **Options** pad and turn the selector dial to Sabbath and press to select. The display will show “During Sabbath Mode the upper oven is unavailable.” Press the selector dial to continue. Any upper oven features running will exit, and the lower oven will immediately transition into Sabbath mode.

To Change Temperature

Once in Sabbath mode, in order to change oven temperature or start a bake feature, the user can change temperature to one of 10 pre-set temperatures as indicated below:

UI Key	Temp. (°F)
Left Side Keys (Upper Oven)	
Microwave	170
Speed Cook/ Defrost	200
Cooking Options/ Popcorn	225
Add 30 Sec	250
Convection Bake/Reheat	300
Right Side Keys (Lower Oven)	
Back	0
Clear/Off	Cancels immediately
Light	325
Bake	350
Broil	375
Convection Bake/Warm	400
Options	450

Changing to one of the above temperatures requires the user to press the keypad associated with the desired temperature and then press the **Start/Pause** pad. For example, to set a Bake 350°F, the user will press the **Bake** pad on the lower oven and then press **Start/Pause** pad.

The Bake feature will start (or if already running, the oven temperature will change) at a random time between 30 – 60 seconds after the **Start/Pause** pad is pressed, with the exception of pressing the **Clear/Off** pad, which will immediately cancel the cooking settings. (The unit will remain in Sabbath mode). Change of temperature may be executed at any time in the cooking cycle.

To Turn Oven Off

Press **Clear/Off** pad or **Back** and then **Start** pads at any time. The oven will immediately turn off but will stay in Sabbath mode and return to the standby Sabbath display screen.

To Exit Sabbath Mode

Press and hold the **Back** pad for 3 seconds. The oven will shut down at a random time between 30 – 60 seconds after the **Back** pad is pressed and held.

NOTE: Do not press any other pads during this time, or the Sabbath mode will be re-initialized and will not exit.

The oven will exit Sabbath mode and return to its default screen.

Timed Cook Feature In Sabbath Mode

The Sabbath mode is not capable of running a timed cook feature on its own. If there is a desire to run a Timed Cook, the following steps must be followed:

1. Use the **Settings** pad to set your Beeper Volume to Mute.
2. Use the **Light** pad to set your lower oven Light to On.
3. Use **Bake** to program a temperature. After programming a temperature select a cook time and enter your cook time. Press **Start** to start the oven. **NOTE:** Convection Bake should NOT be used.
4. Once the oven is started, do NOT open the door until the oven has finished preheating and reached a steady state temperature. Doing so prior to preheating completing will result in the air distribution fan de-energizing immediately upon door opening.
5. Once the food has been placed in the oven, do not open the door until cooking has completed. Doing so will result in the display on the screen changing to prompt you to close your door.
6. Do NOT open the upper oven door. Doing so will turn the light on immediately.
7. Do not press any additional buttons on the lower oven controls once started or the display will change immediately upon the button press.

NOTES

- During Sabbath mode only lower oven Bake is available. Broil, Convection Bake, Warm, or other functions are not available.
- When in Sabbath mode, the 12-hour auto shutoff is disabled regardless of the setting selected in the **Settings**.
- Sabbath mode can be entered only if no cooking mode is running in the lower oven. Entering the Sabbath Mode will cancel all functions in the lower and upper oven (including timer and reminder).
- When any buttons are pressed in Sabbath Mode, there are no beeps or tones, no changes to lights or change in the display. Also, when the door is opened or closed in Sabbath Mode, there are no beeps or tones, no changes to lights or change in the display.
- If a power outage occurs during Sabbath mode baking, the unit will return to Sabbath Mode when power comes back, but will not return in the baking mode.

Cooking Guide (27" Oven)

FOOD TYPE	RECOMMENDED MODE(S)	RECOMMENDED RACK POSITION(S)	ADDITIONAL SUGGESTIONS
Baked Goods			
Layer cakes, sheet cakes, bundt cakes, muffins, quick breads on a Single Rack	Traditional Bake	3	Use shiny cookware.
Chiffon cakes (angel food)	Traditional Bake	1	Use shiny cookware.
Cookies, biscuits, scones on a Single Rack	Traditional Bake	3	Use shiny cookware.
Cakes, Cookies, biscuits, scones on Multiple Racks	Convection Bake Multi	3 and 5 1, 3 and 5	Extension rack position 3. Ensure adequate airflow.
Beef & Pork			
Hamburgers	Broil Hi	5	Use the extension rack and use a broil pan; move food down for more doneness/less searing. Watch food closely when broiling. For best performance center food below the broil heating element.
Steaks & Chops	Broil Hi	5	Use a broil pan; Move food down for more doneness/less searing. Watch food closely when broiling. For best performance center food below the broil heating element.
Roasts	Convection Roast	2 or 3	Use a low sided pan such as a broil pan. Preheating is not necessary.
Poultry			
Whole chicken	Convection Roast	2 or 3	Use a low sided pan such as a broil pan.
Bone-in chicken breasts, legs, thighs	Broil Hi	1	If breaded or coated in sauce avoid Broil Hi modes. Broil skin side down first. Watch food closely when broiling. For best performance when broiling, center food below the broil heating element.
	Broil Lo Traditional Bake Convection Bake 1 Rack	3	
Boneless chicken breasts	Broil Lo Traditional Bake Convection Bake 1 Rack	3	Move food down for more doneness/less searing and up for greater searing/browning when broiling. For best performance when broiling, center food below the broil heating element.
Whole turkey	Convection Roast	1 or 2	Use a low sided pan such as a broil pan.
Turkey breast	Convection Roast	2 or 3	Use a low sided pan such as a broil pan.
Fish	Broil Lo	5 (1/2 thick or less) 4 (>1/2 inch)	Watch food closely when broiling. For best performance center food below the broil heating element.
Casseroles	Convection Bake 1 Rack Traditional Bake	3	
Frozen Convenience Foods			
Pizza, french fries, tator tots, chicken nuggets, appetizers on a Single Rack	Convection Bake 1 Rack Traditional Bake	3	Use shiny cookware.
Pizza, french fries, tator tots, chicken nuggets, appetizers on Multiple Racks	Convection Bake Multi	3 and 5	Use shiny cookware.

*When baking four cake layers at a time, use racks 3 extension and 5 flat with convection multi. Place the pans as shown so that one pan is not directly above another.

Cook food thoroughly to help protect against food borne illness. Minimum safe food temperature recommendations for food safety can be found at IsItDoneYet.gov. Make sure to use a food thermometer to take food temperatures.

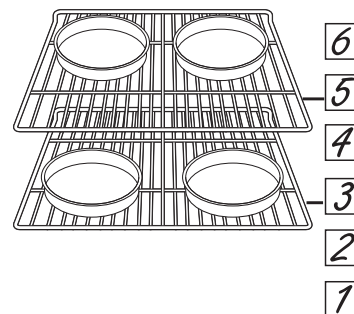

Cooking Guide (30" Oven)

FOOD TYPE	RECOMMENDED MODE(S)	RECOMMENDED RACK POSITION(S)	ADDITIONAL SUGGESTIONS
Baked Goods			
Layer cakes, sheet cakes, bundt cakes, muffins, quick breads on a Single Rack	Traditional Bake	3	Use shiny cookware.
Layer cakes* on Multiple Racks	Traditional Bake	2 and 4	Extension rack in higher position if used. Ensure adequate airflow (see illustration below).
Chiffon cakes (angel food)	Traditional Bake	1	Use shiny cookware.
Cookies, biscuits, scones on a Single Rack	Traditional Bake	3	Use shiny cookware.
Cookies, biscuits, scones on Multiple Racks	Convection Bake Multi	2 and 4 1, 3 and 5	Extension rack position 4 for 2 racks, 1 for 3 racks. Ensure adequate airflow.
Beef & Pork			
Hamburgers	Broil Hi	5	Use the extension rack and use a broil pan; move food down for more doneness/less searing. Watch food closely when broiling. For best performance center food below the broil heating element.
Steaks & Chops	Broil Hi	5	Use a broil pan; Move food down for more doneness/less searing. Watch food closely when broiling. For best performance center food below the broil heating element.
Roasts	Convection Roast	2 or 3	Use a low sided pan such as a broil pan. Preheating is not necessary.
Poultry			
Whole chicken	Convection Roast	2 or 3	Use a low sided pan such as a broil pan.
Bone-in chicken breasts, legs, thighs	Broil Hi	1	If breaded or coated in sauce avoid Broil Hi modes. Broil skin side down first. Watch food closely when broiling. For best performance when broiling, center food below the broil heating element.
	Broil Lo Traditional Bake Convection Bake 1 Rack	3	
Boneless chicken breasts	Broil Lo Traditional Bake Convection Bake 1 Rack	3	Move food down for more doneness/less searing and up for greater searing/browning when broiling. For best performance when broiling, center food below the broil heating element.
Whole turkey	Convection Roast	1 or 2	Use a low sided pan such as a broil pan.
Turkey breast	Convection Roast	2 or 3	Use a low sided pan such as a broil pan.
Fish	Broil Lo	5 (1/2 thick or less) 4 (>1/2 inch)	Watch food closely when broiling. For best performance center food below the broil heating element.
Casseroles	Convection Bake 1 Rack Traditional Bake	3	
Frozen Convenience Foods			
Pizza, french fries, tator tots, chicken nuggets, appetizers on a Single Rack	Convection Bake 1 Rack Traditional Bake	3	Use shiny cookware.
Pizza, french fries, tator tots, chicken nuggets, appetizers on Multiple Racks	Convection Bake Multi	2 and 4	Use shiny cookware.

*When baking four cake layers at a time, use racks 2 and 4. Place the pans as shown so that one pan is not directly above another.

Cook food thoroughly to help protect against food borne illness. Minimum safe food temperature recommendations for food safety can be found at www.IsItDoneYet.gov. Make sure to use a food thermometer to take food temperatures.

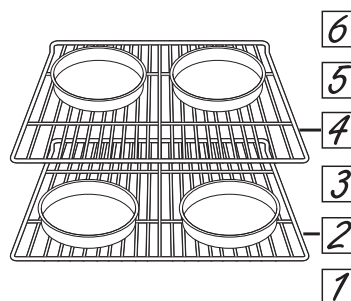

Racks

Your oven has six rack positions. Recommended rack positions for various types of foods are provided in the Cooking Guide. Adjusting rack position is one way to impact cooking results. For example, if you would prefer darker tops on cakes, muffins, or cookies, try moving food one rack position higher. If you find foods are too brown on top try moving them down next time.

When baking with multiple pans and on multiple racks, ensure there is at least 1½" between pans to allow sufficient space for air to flow.

Oven Racks

Your oven may have extension racks and/or traditional flat racks.

To avoid possible burns, place the racks in the desired position before you turn the oven on.

Extension Racks

Extension racks have an install feature that locks into the rack supports (guides) on both sides. Once the install feature is locked into place, always pull the rack out, by its upper front rail, to its full extension stop position, when placing or removing cookware.

If extension racks are difficult to extend, lubricate the racks with the graphite lubricant provided with your oven. Remove the rack from the oven, remove debris in the slide tracks with a paper towel, shake the graphite lubricant and place 4 small drops on the two bottom tracks of the left and right sides. Open and close the rack several times to distribute the lubricant.

To order additional graphite lubricant, see the Accessories and Consumer Support sections at the end of this manual.

To Remove An Extension Rack:

1. Make sure the rack is pushed all the way into the oven.
2. Grasp the rack by both its upper front rail and its lower handles on two sides and lift straight up to unlock the rack from the rack supports.
3. Firmly holding onto both the upper front rail and lower handles on both sides, pull the rack forward. Grasp the rack on both sides if necessary. Then remove it from the oven.

To Replace An Extension Rack:

1. Place the rear portion of the rack onto the rack supports (guides) as shown in the picture.
2. Hold the upper front rail and lower handles and push the rack all the way in until the install feature locks into the front rack support.

If extension racks are difficult to replace or remove, wipe the oven rack supports with vegetable oil. Do not wipe oil on the rack slides.

NOTE: Using other cooking oils will cause a discoloring or a rust like color residue on the racks and cavity sides. To clean this residue, use a soap and water or a vinegar and water solution. Rinse with clean water and dry with a soft cloth.

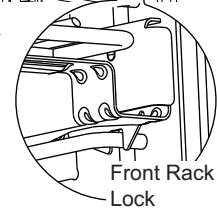
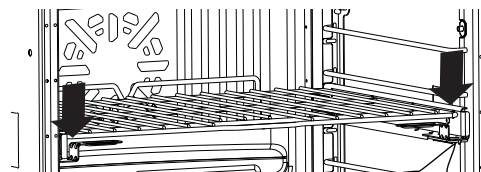
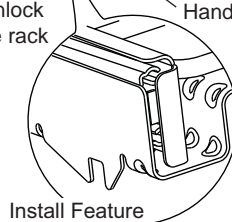
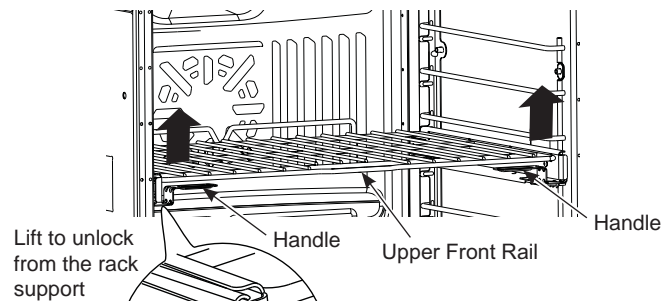
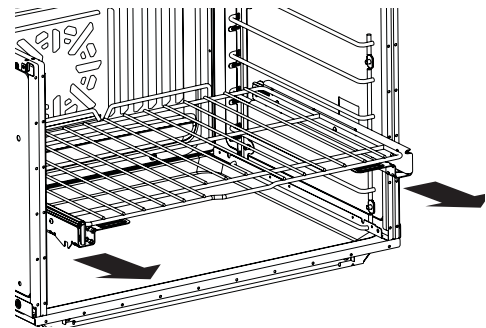
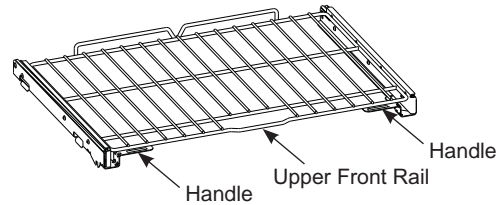
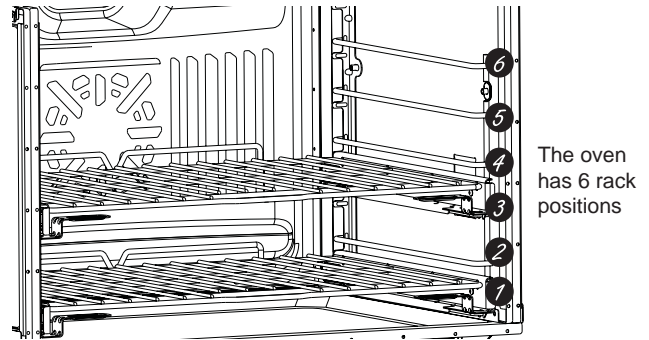

Racks (Cont.)

Traditional Flat Racks

The racks have stops so that when placed correctly on the supports they will stop before coming completely out and will not tilt. When placing and removing cookware, pull the rack out until it stops.

To Remove a Rack

Pull it toward you, tilt the front end up and pull it out.

To Replace a Rack

Tilt the front of the rack up, hook the rear locating posts under the rack supports, push the rack back (past the stop-locks) and lower it into position. Push the rack all the way in.

Racks may become difficult to slide, especially after a self-clean. Put some vegetable oil on a soft cloth or paper towel and rub onto the left and right edges.

NOTE: Using other cooking oils will cause a discoloring or a rust like color residue on the racks and cavity sides. To clean this residue, use a soap and water or a vinegar and water solution. Rinse with clean water and dry with a soft cloth.

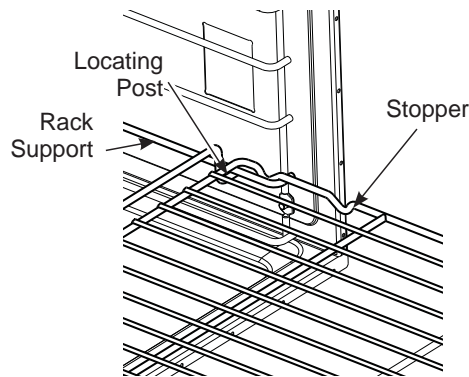
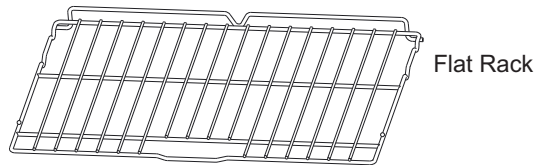

⚠ CAUTION

Use caution when removing a rack from lowest position as door may be hot.

Aluminum Foil and Oven Liners

⚠ CAUTION

Do not use any type of foil or oven liner to cover the oven bottom. These items can trap heat or melt, resulting in damage to the product and risk of shock, smoke or fire. Damage from improper use of these items is not covered by the product warranty.

Foil may be used to catch spills by placing a sheet on a lower rack, several inches below the food. Do not use more foil than necessary and never entirely cover an oven rack with aluminum foil. Keep foil at least 1-1/2" from oven walls to prevent poor heat circulation.

Cookware

Cookware Guidelines

The material, finish, and size of cookware affect baking performance.

Dark, coated and dull pans absorb heat more readily than light, shiny pans. Pans that absorb heat more readily can result in a browner, crisper, and thicker crust. If using dark and coated cookware check food earlier than minimum cook time. If undesirable results are obtained with this type of cookware consider reducing oven temperature by 25° F next time.

Shiny pans can produce more evenly cooked baked goods such as cakes and cookies.

Glass and ceramic pans heat slowly but retain heat well. These types of pans work well for dishes such as pies and custards.

Air insulated pans heat slowly and can reduce bottom browning.

Keep cookware clean to promote even heating.

Cleaning The Oven

Be sure electrical power is off and all surfaces are cool before cleaning any part of the oven.

Helpful Hints

An occasional thorough wiping with a solution of baking soda and water keeps the inside fresh. Also we recommend against using cleaners with ammonia or alcohol, as they can damage the appearance of the oven. If you choose to use a common household cleaner, first apply the cleaner directly to a clean cloth, then wipe the soiled area.

Control Panel

It's a good idea to wipe the control panel after each use. Clean with mild soap and water or vinegar and water, rinse with clean water and polish dry with a soft cloth.

Do not use abrasive cleansers, strong liquid cleansers, plastic scouring pads or oven cleaners on the control panel—they will damage the finish.

Oven Exterior

Do not use oven cleaners, abrasive cleansers, strong liquid cleansers, steel wool, plastic scouring pads, or cleaning powders on the interior or exterior of the oven. Clean with a mild soap and water or vinegar and water solution. Rinse with clean water and dry with a soft cloth.

When cleaning surfaces, make sure that they are at room temperature and not in direct sunlight.

If stain on the door vent trim is persistent, use a mild abrasive cleaner and a sponge-scrubber for best results.

Spillage of marinades, fruit juices, tomato sauces and basting liquids containing acids may cause discoloration and should be wiped up immediately. Let hot surfaces cool, then clean and rinse.

Stainless Steel Surfaces (on some models)

Do not use a steel wool pad; it will scratch the surface.

To clean the stainless steel surface, use warm sudsy water or a stainless steel cleaner or polish. Always wipe the surface in the direction of the grain. Follow the cleaner instructions for cleaning the stainless steel surface.

To inquire about purchasing cleaning products including stainless steel appliance cleaner or polish, see the Accessories and Consumer Support sections at the end of this manual.

How To Clean The Upper Oven Interior

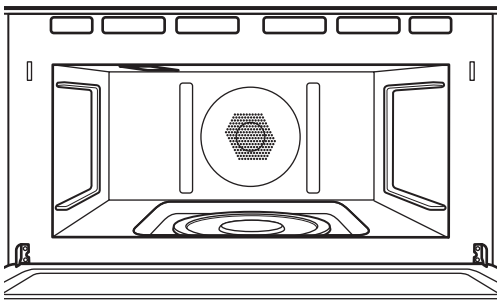

Walls, Floor, Inside Window, Metal and Plastic Parts on the Door

Clean the inside of the oven often for proper heating performance.

Some spatters can be removed with a paper towel, others may require a warm soapy cloth. Remove greasy spatters with a sudsy cloth; then rinse with a damp cloth.

Do not use abrasive cleaners or sharp utensils on oven walls.

Never use a commercial oven cleaner on any part of your oven.

Do not clean the inside of the oven with metal scouring pads. Pieces can break off the pad, causing electrical shock.

Door Seal

It's important to keep the area clean where the door seals against the oven. Use only mild, nonabrasive detergents applied with a clean sponge or soft cloth. Rinse well.

Removable Turntable

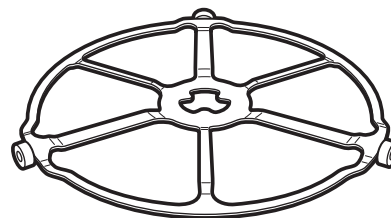

Turntable

Do not use the oven without the turntable in place.

The area underneath the turntable should be cleaned frequently to avoid odors and smoking during a cooking cycle.

The turntable can be broken if dropped. Wash carefully in warm, sudsy water. Dry completely and replace.

To replace the turntable, place its center over the spindle in the center of the oven and turn it until it seats into place. (Make sure the smooth side of the turntable is facing up and that its center seats securely on the spindle.)

Cleaning The Oven (Cont.)

How To Clean The Upper Oven Interior (Cont.)

Cooking Trays And Baking Sheet

To prevent breakage, allow the trays to cool completely before cleaning. Wash carefully in warm, sudsy water or in the dishwasher.

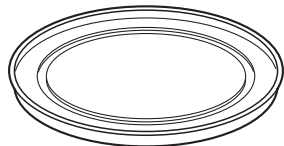

Clear glass tray for microwaving

Do not use metal scouring pads or abrasives, as they may damage the finish. A soap-filled scouring pad may be used to clean the trays.

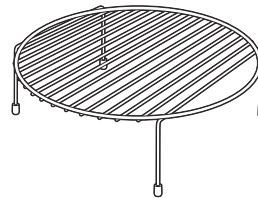

Put food on the wire oven rack, and place them on the glass tray, when baking on two levels.

How To Clean The Lower Oven Interior

The interior of your new oven can be cleaned manually or by using the Steam Clean or Self Clean modes.

Spillage of marinades, fruit juices, tomato sauces and basting liquids containing acids may cause discoloration and should be wiped up immediately. Let hot surfaces cool, then clean and rinse.

Manual Cleaning

Do not use oven cleaners, abrasive cleaners, strong liquid cleansers, steel wool, scouring pads, or cleaning powders on the interior of the oven. Clean with a mild soap and water or vinegar and water solution. Rinse with clean water and dry with a soft cloth. When cleaning surfaces, make sure that they are at room temperature.

Steam Clean Mode

Steam clean is intended to clean small spills using water and a lower cleaning temperature than Self Clean.

To use the Steam Clean feature, wipe grease and soils from the oven. Pour one cup of water into the bottom of the oven. Close the door. Press the **Options** pad, select Steam Clean, and then press **Start**. The oven door will lock. You can not open the door during the 30 minute steam clean as this will decrease the steam clean performance. At the end of the steam clean cycle the door will unlock. Wipe out any excess water and any remaining soil.

Self Clean Mode

Read Self-Cleaning Oven Safety Instructions at the beginning of this manual before using Self Clean Mode. Self-clean uses very high temperatures to clean the oven interior. The oven door will lock when using this feature. Before operating the self-clean cycle, wipe up grease and soils from the oven. Remove all items from the oven other than enameled (dark color) racks. Shiny or silver racks and any cookware or other items should all be removed from the oven before initiating a self-clean cycle. Close the door. Press the **Options** pad, select Self Clean, and a default self-clean time is displayed. The clean time can be changed to 3:00, 4:00, or 5:00 hours by using the selector dial. For heavily soiled ovens, the maximum 5 hour clean time is recommended. If you wish to use the default time, press the **Start** pad immediately after selecting the Self Clean. The oven will turn off automatically when the self-clean cycle is complete. The door will stay locked until the oven has cooled down. After the oven has cooled down wipe any ash out of the oven.

IMPORTANT: The health of some birds is extremely sensitive to the fumes given off during the self-cleaning cycle of any range. Move birds to another well-ventilated room.

Lower Oven Racks

The racks that were provided with your oven (dark enameled racks, not shiny) may remain in the oven during the self-cleaning cycle without being damaged.

To manually clean racks, use warm, soapy water. Make sure not to wash the rack slides on an extension rack.

If racks become more difficult to remove from the oven, put some vegetable oil on a soft cloth or paper towel and rub onto the oven rack supports. Do not wipe the oil on an extension rack slide.

NOTE: Using other cooking oils will cause a discoloring or a rust like color residue on the racks and cavity sides. To clean this residue, use a soap and water or a vinegar and water solution. Rinse with clean water and dry with a soft cloth.

Periodically, after several self-clean cycles, the extension rack slides may need to be lubricated using the graphite lubricant shipped with your wall oven. To order additional temperature probes, see the Accessories and Consumer Support sections at the end of this manual.

1. Remove extension rack from the oven. See the Extension Oven Racks section.
2. Fully extend the rack on a table or countertop. Newspaper may be placed underneath the rack for easy clean up.
3. If there is debris in the slide tracks, wipe it away using a paper towel. **NOTE:** Any graphite lubricant wiped away must be replaced.
4. Shake the graphite lubricant before opening it. Starting with left slide mechanism of the rack, place four (4) small drops of lubricant on the two (2) bottom tracks of the slide close to the bearing carriers.
5. Repeat for the right slide mechanism of the rack.
6. Open and close the rack several times to distribute the lubricant.
7. Replace the cap on the lubricant and shake it again. Turn the rack over and repeat steps 3, 4, 5 and 6.
8. Close the rack, turn rack right-side-up and place in the oven. See the Extension Oven Racks section.
9. Repeat above steps for each rack.

NOTE: Do not spray with cooking spray or other lubricant sprays.

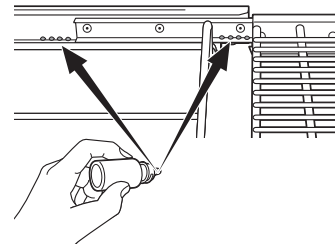
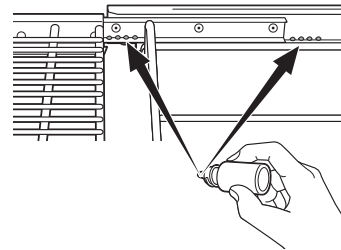
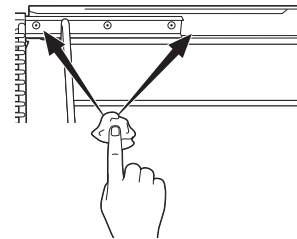
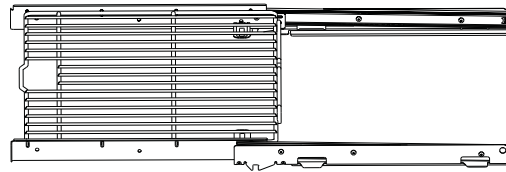

Lower Oven Maintenance

Lower Oven Light Replacement

⚠ WARNING **SHOCK OR BURN HAZARD:** Before replacing oven light bulb, disconnect the electrical power to the oven at the main fuse or circuit breaker panel. Failure to do so may result in electric shock or burn.

⚠ CAUTION **BURN HAZARD:** The glass cover and bulb should be removed when cool. Touching hot glass with bare hands or a damp cloth can cause burns.

1. Disconnect power at the main fuse or circuit breaker panel.
2. Remove oven racks.
3. Slide a flat blade screwdriver between the housing and the glass light cover.
4. Support the glass light cover with two fingers to prevent the cover from falling to the bottom of the oven. Be careful not to chip the oven coating.
5. Gently twist the screwdriver blade to loosen the glass light cover.
6. Remove the glass light cover.
7. Remove the bulb by firmly grasping and sliding the bulb straight out until the two prongs have cleared the ceramic holder.
8. Do not touch the glass of the new replacement bulb with your fingers. It will cause the bulb to fail when it lights. Grasp the replacement bulb with a clean towel or facial tissue with the prongs facing down. Align the two prongs in the ceramic holder, pressing gently until the bulb is securely in the ceramic socket.
9. Slide the protective lens into the holder and push until the clips snap into the housing.
10. Reconnect power.

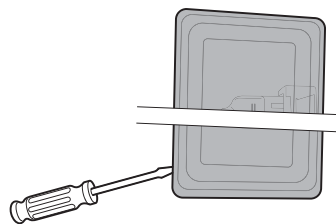

Use a small flat blade screwdriver to remove the lamp lens cover.

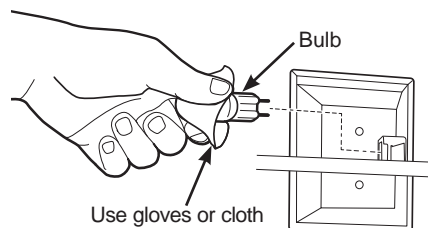

Use gloves or cloth

Lift-Off Lower Oven Door

The door is very heavy. Be careful when removing and lifting the door. Do not lift the door by the handle.

To remove the door:

1. Fully open the door.
2. Pull the hinge locks down toward the door frame, to the unlocked position. A tool, such as a small flat-blade screwdriver, may be required.
3. Firmly grasp both sides of the door at the top.
4. Close door to the door removal position. The door should be open approximately 3" with no obstruction above the door.
5. Lift door up and out until both hinge arms are clear of the slots.

To replace the door:

1. Firmly grasp both sides of the door at the top.
2. Starting on the left side, with the door at the same angle as the removal position, seat the indentation of the hinge arm into the bottom edge of the hinge slot. The notch in the hinge arm must be fully seated into the bottom of the slot. Repeat for right side.
3. Fully open the door. If the door will not fully open, the indentation is not seated correctly in the bottom edge of the slot.
4. Push the hinge locks up against the front frame of the oven cavity, to the locked position.
5. Close the oven door.

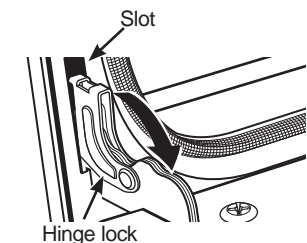

Pull hinge locks down to unlock

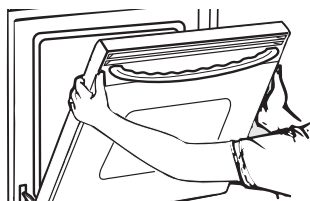

Removal position

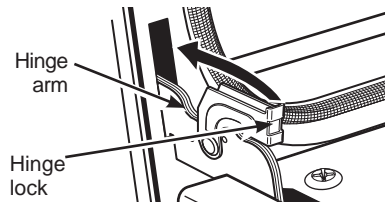

Push hinge locks up to lock

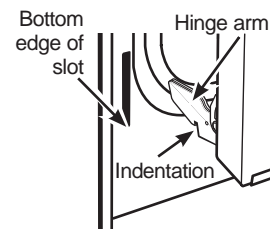

Troubleshooting tips ... Before you schedule service

Save time and money! Review the charts on the following pages first and you may not need to schedule service.

Problem	Possible Cause	What To Do
FAN		
Fan continues to run after cooking stops	The oven is cooling.	The fan will automatically shut off when the internal parts of the oven have cooled.
Oven vent emits warm air while oven is on	This is normal.	
Fan comes on automatically when using the microwave	This is normal.	
COOKING		
The oven makes unusual sounds while cooking	Clicks and fans blowing are normal. The relay board is turning the components on and off.	These sounds are normal.
Smoke comes out of the oven when I open the door	Food is high in fat content. Aerosol spray used on the pans.	Smoke is normal when cooking high-fat foods.
Food is not fully cooked or browned at the end of a cooking program	Programmed times may not match the size or amount of food you are cooking.	Adjust time for doneness or adjust the upper or lower lamps for browning and doneness.
SENSOR ERROR displayed along with an oven signal	Food amount or type placed in the oven does not match the program that was set.	Press the Clear/Off pad. Set the oven program to match the food or liquid to be cooked or heated.
	Steam was not sensed by the oven because plastic wrap was not vented, a lid too tight was on the dish or a liquid was covered.	Vent plastic wrap, use a looser lid or uncover liquids when cooking or heating.
DISPLAY		
The display is blank	Power saver mode may be activated.	Check the Settings menu for clock display settings. Turn the display on.
	A fuse in your home may be blown or the circuit breaker tripped.	Replace the fuse or reset the circuit breaker.
	Power outage or surge	Reset the clock. If the oven was in use, you must reset it by pressing the Clear/Off pad, setting the clock and resetting any cooking function.
"Control is LOCKED" appears in display	The control has been locked.	Press and hold Settings pad for 3 seconds to unlock the control.
Control display is lit yet oven will not start	Clock is not set.	Set the clock.
	Door not securely closed.	Open the door and close securely.
	Start/Pause pad or selector dial not pressed after entering cooking selection.	Press Start/Pause pad or selector dial.
	Another selection already entered in oven and Clear/Off pad not pressed to cancel it.	Press Clear/Off pad.
	Size, quantity or cooking time not entered after final selection.	Make sure you have entered cooking time after selecting.
	Clear/Off pad was pressed accidentally.	Reset cooking program and press Start/Pause pad.
OTHER PROBLEMS		
The door and inside of the oven feels hot	The heat lamps produce intense heat in a small space.	This is normal. Use oven mitts to remove food when ready.
Oven will not start	A fuse in your home may be blown or the circuit breaker tripped.	Replace fuse or reset circuit breaker.
Cannot edit cooking features	Some pre-programmed cooking features may not be able to be edited to prevent degradation of cooking performance.	This is normal.
The pads on one side of the control do not function	The control has locked out the use of these pads and need to be reset.	Press and hold the Clear/Off pad on the other side of the display for 30 seconds. If this does not reset the control, it may be necessary to cycle the circuit breaker.

Troubleshooting tips ... Before you schedule service

Problem	Possible Cause	What To Do
My new oven doesn't cook like my old one. Is something wrong with the temperature settings?	Your new oven has a different cooking system from your old oven and therefore may cook differently than your old oven.	For the first few uses, follow your recipe times and temperatures carefully. If you still think your new oven is too hot or too cold, you can adjust the temperature yourself to meet your specific cooking preference. NOTE: This adjustment affects Bake, Convection Bake 1 Rack and Convection Bake Multi temperatures; it will not affect Convection Roast, Broil, or Clean.
Food does not bake properly	Oven controls improperly set.	See the Cooking Modes section.
	Rack position is incorrect or rack is not level.	See the Cooking Modes section and Cooking Guide.
	Incorrect cookware or cookware of improper size being used.	See the Cookware section.
	Oven temperature needs adjustment.	See the Settings section.
	Ingredient substitution	Substituting ingredients can change the recipe outcome.
Food does not broil properly	Oven controls improperly set.	Make sure you select the appropriate broil mode.
	Improper rack position being used.	See Cooking Guide for rack location suggestions.
	Food being cooked in a hot pan.	Make sure cookware is cool.
	Cookware not suited for broiling.	Use a pan specifically designed for broiling.
	Aluminum foil used on the broiling pan and grid has not been fitted properly and slit as recommended.	If using aluminum foil conform to pan slits.
	In some areas the power (voltage) may be low.	Preheat the broil element for 10 minutes.
Oven temperature too hot or too cold	Oven temperature needs adjustment.	See the Settings section.
Oven does not work or appears not to work	A fuse in your home may be blown or the circuit breaker tripped.	Replace the fuse or reset the circuit breaker.
	Oven controls improperly set.	See the Using the Oven section.
	Oven is in Sabbath Mode.	Verify, that the oven is not in Sabbath Mode. See the Sabbath Mode section.
"Crackling" or "popping" sound	This is the sound of the metal heating and cooling during both the cooking and cleaning functions.	This is normal.
Why is my range making a "clicking" noise when using my oven?	Your range has been designed to maintain a tighter control over your oven's temperature. You may hear your oven's heating elements "click" on and off more frequently than in older ovens to achieve better results during baking, broiling, convection, and self-clean cycles.	This is normal.
Clock and timer do not work	A fuse in your home may be blown or the circuit breaker tripped.	Replace the fuse or reset the circuit breaker.
Oven light does not work	Light bulb is loose or defective.	Tighten or replace bulb.
	Pad operating light is broken.	Call for service.
Oven will not self-clean	The temperature is too high to set a self-clean operation.	Allow the oven to cool and reset the controls.
	Oven controls improperly set.	See the Cleaning the Oven section.
Excessive smoking during clean cycle	Excessive soil or grease.	Press the Clear/Off pad. Open the windows to rid the room of smoke. Wait until the OVEN IS COOLING DOOR IS LOCKED display goes off. Wipe up the excess soil and reset the clean cycle.
Excessive smoking during broiling	Food too close to burner element.	Lower the rack position of the food.
Oven door will not open after a clean cycle	Oven too hot.	Allow the oven to cool below locking temperature.

Troubleshooting tips ... Before you schedule service

Problem	Possible Cause	What To Do
Oven not clean after a clean cycle	Oven controls improperly set.	See the Cleaning the Oven section.
	Oven was heavily soiled.	Clean up heavy spillovers before starting the clean cycle. Heavily soiled ovens may need to self-clean again or for a longer period of time.
"CLOSE DOOR TO CONTINUE COOKING" show on display section	The door is open during a cooking or cleaning feature.	Close the oven door.
"OVEN IS COOLING DOOR IS LOCKED" show on display section	The oven door is locked because the temperature inside the oven has not dropped below the unlocking temperature.	Press the Clear/Off pad. Allow the oven to cool.
An oven error and "SERVICE MAY BE NEEDED" show in the display	You have a function error code.	Press the Clear/Off pad. Allow the oven to cool for one hour. Put the oven back into operation.
	If the function code repeats.	Disconnect all power to the oven for at least 30 seconds and then reconnect power. If the function error code repeats, call for service.
"Burning" or "oily" odor emitting from the vent	This is normal in a new oven and will disappear in time.	To speed the process, set a self-clean cycle for a minimum of 3 hours. See the Cleaning the Oven section.
Strong odor	An odor from the insulation around the inside of the oven is normal for the first few times the oven is used.	This is temporary and will go away after several uses or a self-clean cycle.
Fan noise	A cooling fan may automatically turn on.	This is normal. The cooling fan will turn on to cool internal parts. It may run for up to 1-1/2 hours after the oven is turned off.
My oven door glass appears to be "tinted" or have a "rainbow" color. Is this defective?	No. The inner oven glass is coated with a heat barrier to reflect the heat back into the oven to prevent heat loss and keep the outer door cool while baking.	This is normal. Under certain light or angles, you may see this tint or rainbow color.
Sometimes the oven takes longer to preheat to the same temperature	Cookware or food in oven	The cookware or food in the oven will cause the oven to take longer to preheat. Remove items to reduce preheat time.
	Number of racks in oven	Adding more racks to the oven will cause the oven to take longer to preheat. Remove some racks.
	Different cooking modes	The different cooking modes use different preheat methods to heat the oven for the specific cooking mode. Some modes will take longer than others (i.e. convection bake multi).

Notes

Notes

GE Appliances Limited Warranty

GEAppliances.com

All warranty service is provided by our Factory Service Centers, or an authorized Customer Care® technician. To schedule service online, visit us at GEAppliances.com/service, or call GE Appliances at 800.GE.CARES (800.432.2737). Please have your serial number and your model number available when calling for service.

Servicing your appliance may require the use of the onboard data port for diagnostics. This gives a GE Appliances factory service technician the ability to quickly diagnose any issues with your appliance and helps GE Appliances improve its products by providing GE Appliances with information on your appliance. If you do not want your appliance data to be sent to GE Appliances, please advise your technician not to submit the data to GE Appliances at the time of service.

For the period of	GE Appliances will replace
One year From the date of the original purchase	Any part of the oven which fails due to a defect in materials or workmanship. During this limited one-year warranty , GE Appliances will provide, free of charge , all labor and in-home service to replace the defective part.

What GE Appliances will not cover:

- Service trips to your home to teach you how to use the product.
- Improper installation, delivery or maintenance.
- Failure of the product if it is abused, misused, modified or used for other than the intended purpose or used commercially.
- Replacement of house fuses or resetting of circuit breakers.
- Damage to the product caused by accident, fire, floods or acts of God.
- Incidental or consequential damage caused by possible defects with this appliance.
- Damage caused after delivery.
- Product not accessible to provide required service.
- Service to repair or replace light bulbs, except for LED lamps.

EXCLUSION OF IMPLIED WARRANTIES

Your sole and exclusive remedy is product repair as provided in this Limited Warranty. Any implied warranties, including the implied warranties of merchantability or fitness for a particular purpose, are limited to one year or the shortest period allowed by law.

This limited warranty is extended to the original purchaser and any succeeding owner for products purchased for home use within the USA. If the product is located in an area where service by a GE Appliances Authorized Servicer is not available, you may be responsible for a trip charge or you may be required to bring the product to an Authorized GE Appliances Service location for service. In Alaska, the limited warranty excludes the cost of shipping or service calls to your home.

Some states do not allow the exclusion or limitation of incidental or consequential damages. This limited warranty gives you specific legal rights, and you may also have other rights which vary from state to state. To know what your legal rights are, consult your local or state consumer affairs office or your state's Attorney General.

Warrantor: GE Appliances, a Haier company
 Louisville, KY 40225

Extended Warranties: Purchase a GE Appliances extended warranty and learn about special discounts that are available while your warranty is still in effect. You can purchase it online anytime at

GEAppliances.com/extended-warranty

or call 800.626.2224 during normal business hours. GE Appliances Service will still be there after your warranty expires.

Staple your receipt here. Proof of the original purchase date is needed to obtain service under the warranty.

Accessories

Looking For Something More?

GE Appliances offers a variety of accessories to improve your cooking and maintenance experiences!

To place an order visit us online at:

www.GEApplianceParts.com (U.S.) or

www.GEAppliances.ca (Canada) or

call **800.626.2002** (U.S.) **800.661.1616** (Canada)

The following products and more are available:

Accessories

Small Broiler Pan (8 ¾" x 1 ¼" x 13 ½")

Large* Broiler Pan (12 ¾" x 1 ¼" x 16 ½")

XL** Broiler Pan (17" x 1 ¼" x 19 1/4")

Parts

Glass Tray

Turntable

Oven Racks

Oven Elements

Light Bulbs

Cleaning Supplies

16 oz. Micro Bryte® Appliance Cleaner

CitruShine™ Stainless Steel Wipes

CERAMA BRYTE® Stainless Steel Appliance Cleaner

Graphite Lubricant

*The large broiler pan does not fit in 20"/24" ranges.

**The XL broiler pan does not fit in 24" wall ovens, 27" drop ins or 20"/24" ranges

Consumer Support

GE Appliances Website

Have a question or need assistance with your appliance? Try the GE Appliances Website 24 hours a day, any day of the year! You can also shop for more great GE Appliances products and take advantage of all our on-line support services designed for your convenience. In the US: GEAppliances.com

Register Your Appliance

Register your new appliance on-line at your convenience! Timely product registration will allow for enhanced communication and prompt service under the terms of your warranty, should the need arise. You may also mail in the pre-printed registration card included in the packing material. In the US: GEAppliances.com/register

Schedule Service

Expert GE Appliances repair service is only one step away from your door. Get on-line and schedule your service at your convenience any day of the year. In the US: GEAppliances.com/service or call 800.432.2737 during normal business hours.

Extended Warranties

Purchase a GE Appliances extended warranty and learn about special discounts that are available while your warranty is still in effect. You can purchase it on-line anytime. GE Appliances Services will still be there after your warranty expires. In the US: GEAppliances.com/extended-warranty or call 800.626.2224 during normal business hours.

Remote Connectivity

For assistance with wireless network connectivity (for models with remote enable), visit our website at GEAppliances.com/connect or call 800.220.6899 in the US.

Parts and Accessories

Individuals qualified to service their own appliances can have parts or accessories sent directly to their homes (VISA, MasterCard and Discover cards are accepted). Order on-line today 24 hours every day. In the US: GEApplianceparts.com or by phone at 877.959.8688 during normal business hours.

Instructions contained in this manual cover procedures to be performed by any user. Other servicing generally should be referred to qualified service personnel. Caution must be exercised, since improper servicing may cause unsafe operation.

Contact Us

If you are not satisfied with the service you receive from GE Appliances, contact us on our Website with all the details including your phone number, or write to:

In the US: General Manager, Customer Relations | GE Appliances, Appliance Park | Louisville, KY 40225
GEAppliances.com/contact